

care relax

State of the art
healthcare furniture

Fusion & COSMO
COSINESS AND UNIVERSAL DESIGN....

Ino
DESIGN AND CARE UNITED...

LAGUNA
SCANDINAVIAN INSPIRED,
ERGONOMIC DESIGN ...

ECHO
BUDGET-FRIENDLY, SIMPLE ...

NOVA
STYLISH ARCHITECTURAL





CONTENT



p 6-27 \ **Ino**

Design & Care united.

p 28-35 \ **Fusion**

Cosiness and universal design* ...

p 38-43 \ **Laguna**

Scandinavian inspired, ergonomic design ...
with superior care comfort.

p 44-51 \ **Echo**

Budget-friendly, easy to use, simple ...
and comfortable.

p 52-55 \ **Cosmo**

Universal design* ...
comfort for all.

p 56-59 \ **Vento**

Classic lineage combined with the most
modern seating comfort.

p 60-61 \ **Brezza**

Attractive Design ...
with a range of possibilities.

p 62-65 \ **Zeta**

Comfort ...
and cosiness.

p 66-67 \ **Nova**

Stylish ...
Architectural.

MISSION

'Moments Furniture' (since 1935), designs, manufactures and markets furniture for the healthcare sector. We are operating internationally. We have our own Sales Units in Belgium, the Netherlands, France, Switzerland and Germany. Our Manufacturing Units, located in Ingelmunster (BE) and Salzkotten (DE), focus on innovation, quality and craftsmanship.

'Moments Healthcare Furniture's' mission is to create, produce, upholster and assemble innovative and qualitative healthcare furniture, offering more comfort and a feeling of well-being.



p 68-71 \ **Standard models Fusion - Ino - Laguna - Echo**

p 72-73 \ **Options**

p 74-75 \ **Accessories**

p 76-67 \ **Standard models Vento - Brezza - Zeta - Nova**

INO 25.09.2017 , FUSION 01.10.2019
Registered Design

*Universal design is the process of creating products that are accessible to people with a wide range of abilities, disabilities, and other characteristics. Universally designed products accommodate individual preferences and abilities; communicate necessary information effectively and can be approached, reached, manipulated, and used regardless of the individual's body size, posture, or mobility.

Ino

DESIGN & CARE UNITED.

m



ENJOY... pure simplicity.



Ino Casa
Fixed foot
Long 'CARE' handles inside

WATCH OUR INO
PRODUCT VIDEOS!
CLICK HERE OR SCAN THE
QR CODE!



Ino ligna with
ZG mechanism
Medium handles inside
Wooden armrest





Ino Cura with
ZG mechanism
Long "CARE" handles inside
Wooden armrest



Ino Cura NS (wood)
Wheels Ø 125 mm
Central brake (on the right)
Retractable footrest
Ergonomic synthetic push bar



Watching television, enjoying a meal or reading a book... from an active or passive sitting position to an outstanding relax or sleeping position.

TV kijken, genieten van een maaltijd of een boek lezen... van een actieve of passieve zithouding tot een uitstekende relax- of slaaphouding.

Regarder la télévision, déguster un repas ou lire un livre... d'une position assise active ou passive à une position relax ou couchée exceptionnelle.

Fernsehen, genussvoll essen oder ein Buch lesen... von einer aktiven oder passiven Sitzhaltung bis hin zur perfekten Entspannungs- oder Schlafposition.



Ino Casa
Fixed foot with
coffee table

High degree of ergonomic sitting and lying comfort, at home or for the care sector: INO meets every need at any time.

A modern & unique product. User- & maintenance-friendly.



Ino Casa
Fixed foot with
coffee table

Hoog ergonomisch zit- & ligcomfort, voor thuis of voor de zorgsector: de INO voorziet op elk moment in elke behoefte. Een modern en uniek product. Gebruiks- & onderhoudsvriendelijk.

Niveau élevé de confort de couchage et d'assise ergonomique, tant à domicile que pour le secteur des soins de santé : INO répond à tous les besoins à tout moment. Un produit moderne et unique. Facile à utiliser et à entretenir.

Hoher ergonomischer Sitz- und Liegekomfort, zuhause oder im Pflegebereich: INO erfüllt jederzeit sämtliche Bedürfnisse. Ein modernes & einzigartiges Produkt. Bediener- & wartungsfreundlich.

Thanks to its modular construction and numerous care accessories, it is possible to convert the INO into a complete “care version” at all times.



Dankzij de modulaire opbouw en de talrijke zorgaccessoires is het mogelijk om de INO op ieder moment om te bouwen tot een complete 'care' versie.

Grâce à sa structure modulaire et à ses nombreux accessoires de soins, il est toujours possible de convertir l'INO en une 'version soins' complète.

Dank des modularen Aufbaus und des umfangreichen Pflegezubehörs ist es jederzeit möglich, den INO in eine komplette 'Pflegeversion' zu verwandeln.



Ino Cura (wood)
wheels Ø 125 mm:
2 with brake, 1 without brake,
1 direction wheel
retractable footrest
ergonomic plastic push bar
accessories: plastic dining tray

A well-designed light & stable construction in combination with wheels results in an excellent driving behaviour, both indoors and outdoors.

The adjustable armrests of the INO CURA NS allow an easy transfer.



Ino Dolce
Wheels Ø 125 mm:
2 with brake, 1 without brake,
1 direction wheel
Retractable footrest
Ergonomic plastic push bar



Ino Cura NS (wood)
wheels Ø 125 mm
2 with brake, 1 without brake,
1 direction wheel
retractable footrest
ergonomic plastic push bar

Een weldoordachte lichte en stabiele constructie in combinatie met wielen draagt ertoe bij dat de relax een uitstekend rijgedrag bezit, dit zowel voor binnen als voor buiten.

Une structure légère et stable, bien conçue et montée sur roulettes offre une maniabilité excellente, tant en usage extérieur que intérieur.

Eine gut durchdachte, leichte & stabile Konstruktion in Kombination mit Rädern sorgt für ein hervorragendes Manövrierverhalten, drinnen wie draußen.

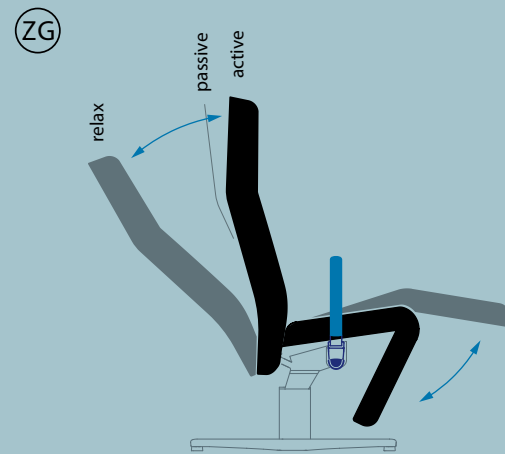

ZERO GRAVITY 130°

Pure simplicity. The back and leg rest are synchronously steplessly adjustable. From an active or passive sitting posture to an excellent relaxing position.

Pure eenvoud. Rug en beensteun zijn synchroon traploos verstelbaar. Van een actieve zithouding tot een uitstekende relaxpositie.

La simplicité à l'état pur. Le dossier et le repose-jambes sont réglables synchrones sans intervalle. L'idéal pour passer d'une position assise active ou passive à une position de relaxation exceptionnelle.

Pure Einfachheit. Rückenlehne und Beinablage sind synchron stufenlos einstellbar. Von der aktiven oder passiven Sitzposition in eine hervorragende Relax-Position.

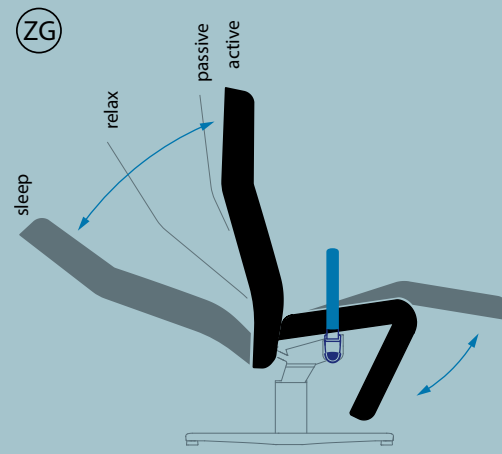

ZERO GRAVITY 140°

Pure simplicity. The back and leg rest are synchronously steplessly adjustable. From an active or passive sitting posture to an excellent sleeping position.

Pure eenvoud. Rug en beensteun zijn synchroon traploos verstelbaar. Van een actieve zithouding tot een uitstekende slaappositie.

La simplicité à l'état pur. Le dossier et le repose-jambes sont réglables synchrones sans intervalle. L'idéal pour passer d'une position assise active ou passive à une position de sommeil exceptionnelle.

Pure Einfachheit. Rückenlehne und Beinablage sind synchron stufenlos einstellbar. Von der aktiven oder passiven Sitzposition in eine hervorragende Relax-Position.

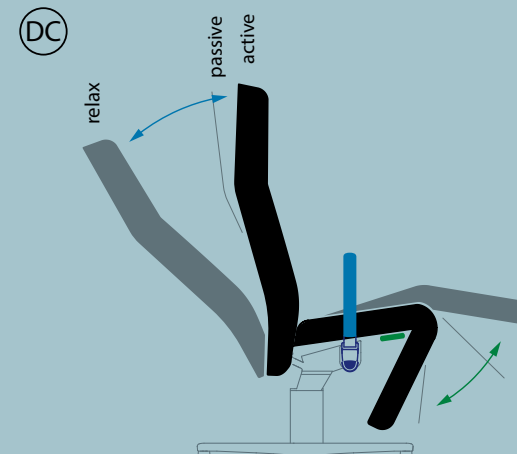

DUO COMFORT SOLO 130°

Duo Comfort Solo guarantees numerous comfort positions where the back and leg rest are **individually steplessly adjustable**.

Duo Comfort Solo staat voor tal van zit- en relaxposities. Rug en beensteun zijn **apart traploos verstelbaar**.

Duo Comfort Solo se porte garant pour différentes positions de confort par lequel le dossier et le repose-jambes sont **réglables séparément sans intervalle**.

Duo Comfort Solo bietet zusätzliche Verstellmöglichkeiten wie das Rücken- und Beinstütze sind **stufenlose und separate verstellbar**.

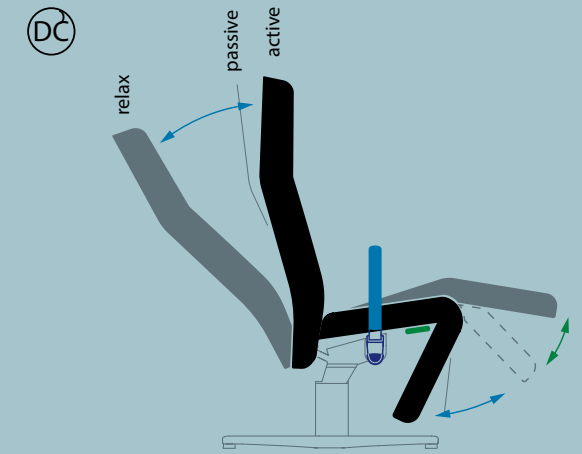

DUO COMFORT SYNCHRO 130°

Ergonomic and easy to use. Back and leg rest electrically and **synchronously stepless adjustable**. Leg rest separately stepless adjustable.

Ergonomie en gemakkelijk in gebruik. Rug en beensteun zijn **synchroon traploos verstelbaar**. Beensteun apart traploos verstelbaar.

Ergonomie et facile à utiliser. Dossier et repose-jambes sont **réglables synchrones sans intervalle**. Repose-jambes sont réglable séparément sans intervalle.

Ergonomie und einfach zu benutzen. Rücken und Beinauflage sind **synchroon stufenlos einstellbar**. Separate, stufenlos verstellbare Beinauflage.

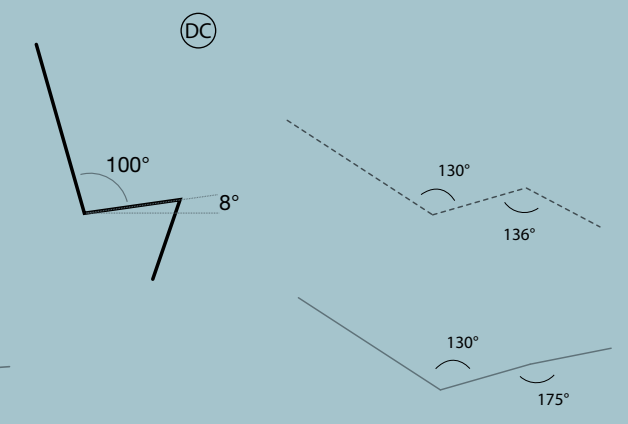
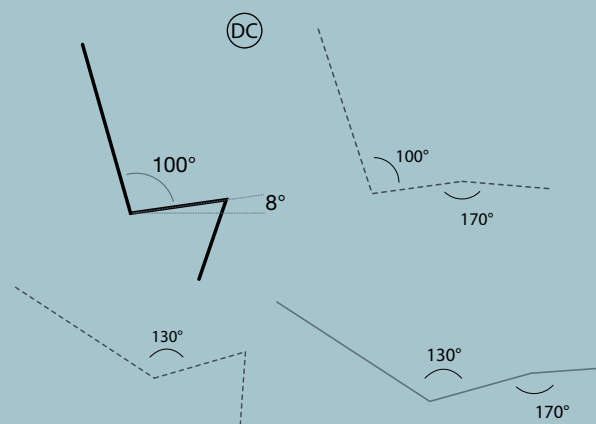
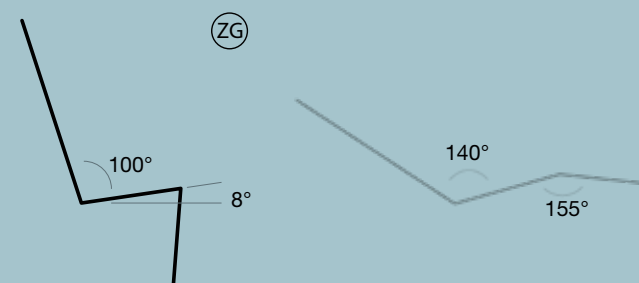
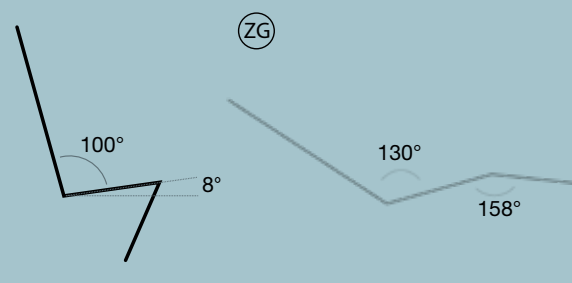

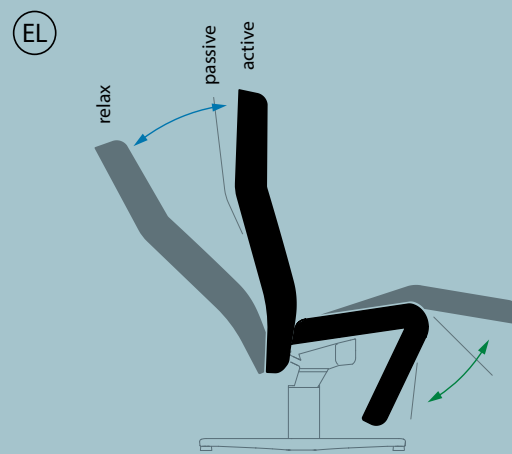

ELECTRIC 125°

Easy to use - Seat, back and leg rest electrically adjustable. Synchronously stepless adjustable or separately adjustable. Optional - removable and rechargeable battery.

Gemakkelijk in gebruik - Zit, rug & beensteun elektrisch verstelbaar, apart of synchroon traploos verstelbaar. Mogelijkheid tot afneembare en oplaadbare batterij.

Facile à utiliser - Assise, dossier et repose-jambes à réglable électrique individuellement ou de manière synchrone en continu. En option - Batterie amovible et rechargeable.

Einfach im Gebrauch - Sitz-, Rücken- & Beinstütze elektrisch verstelbar. Individuell oder synchron stufenlos verstelbar. Möglichkeit einer auswechselbaren und aufladbaren Batterie.

(EL)

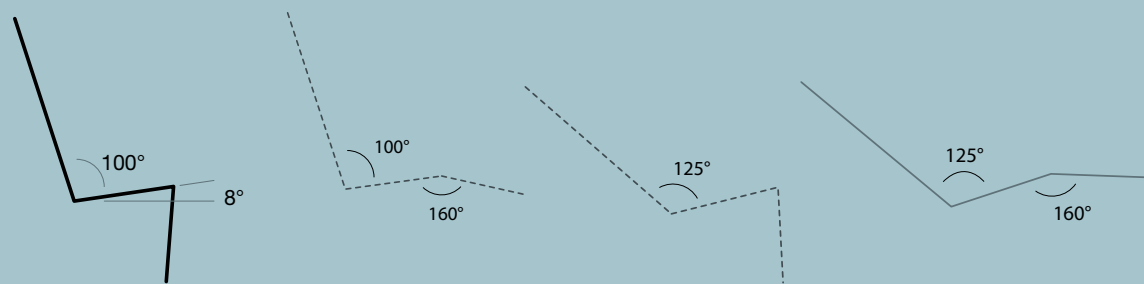

op kleur laten zetten door Peter - moiré aanwezig





INO CASA



INO CASA WHEELS Ø 75



INO CASA WHEELS Ø 125



INO CURA



INO CURA WHEELS Ø 75



INO CURA WHEELS Ø 125



INO CASA WHEELS Ø 125
CENTRAL BRAKE



INO LIGNA



INO LIGNA WHEELS Ø 75



INO CURA WHEELS Ø 125
CENTRAL BRAKE



INO CURA NS



INO CURA NS WHEELS Ø 75



INO LIGNA WHEELS Ø 125



INO LIGNA WHEELS Ø 125
CENTRAL BRAKE



INO CURA NS WHEELS Ø 125



INO CURA NS WHEELS Ø 125
CENTRAL BRAKE



Ino ARMRESTS*

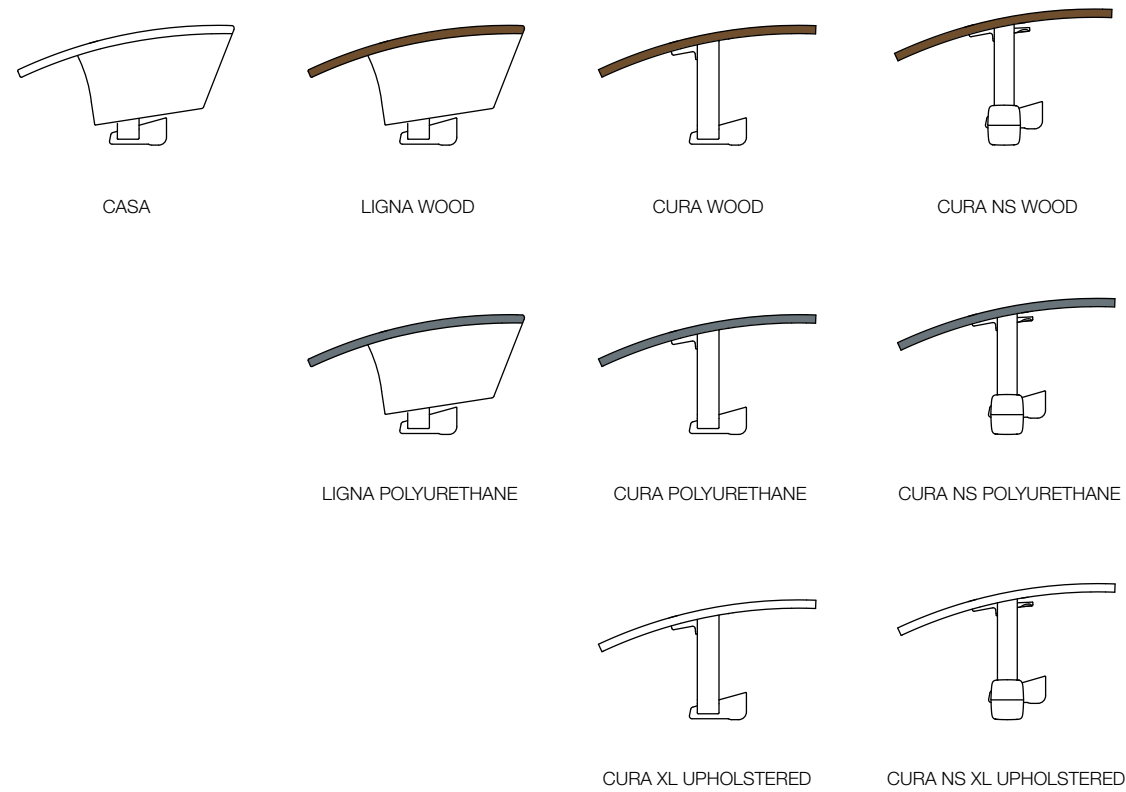

(*) On request, a bespoke arm may be developed.

Ino HANDLES

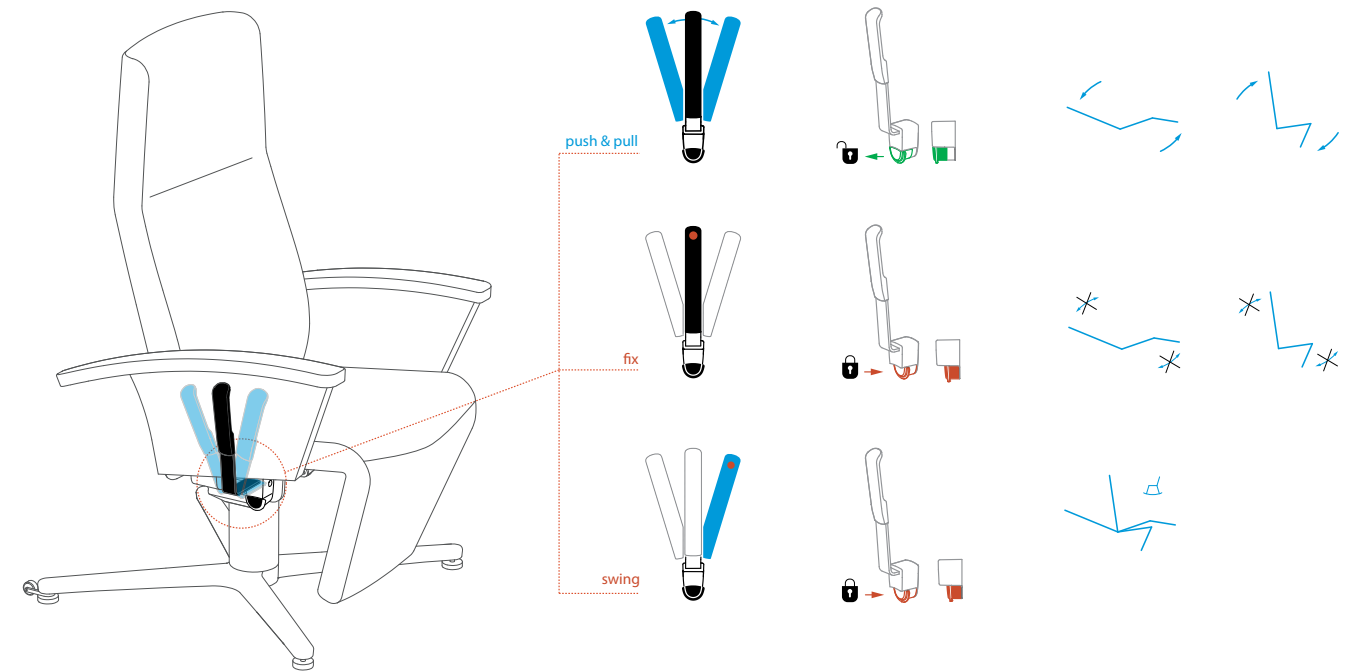

Ino INNOVATIVE X-FOOT

46 - 48 - 50 - 52 - 54 - 56 cm seat height

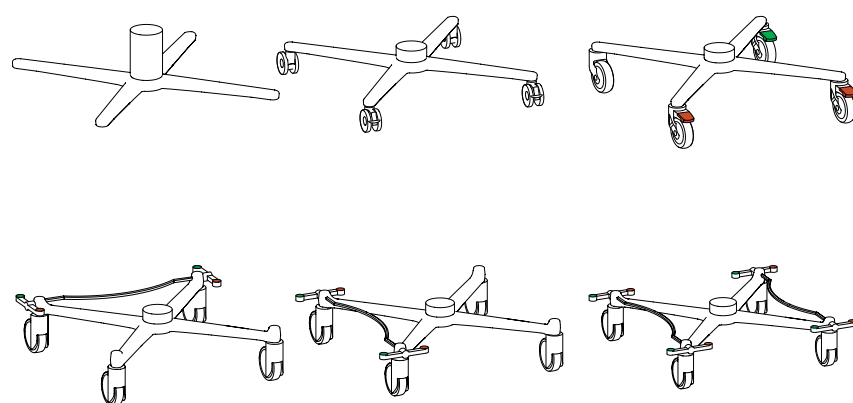

Fusion

COSINESS & UNIVERSAL DESIGN.



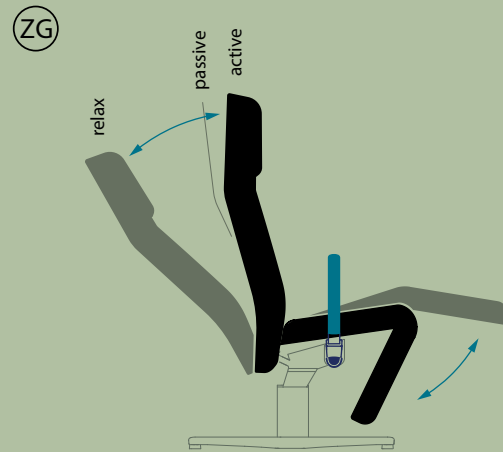

ZERO GRAVITY 130°

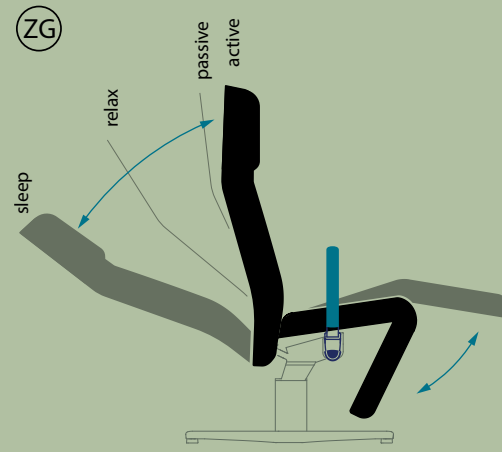

ZERO GRAVITY 140°

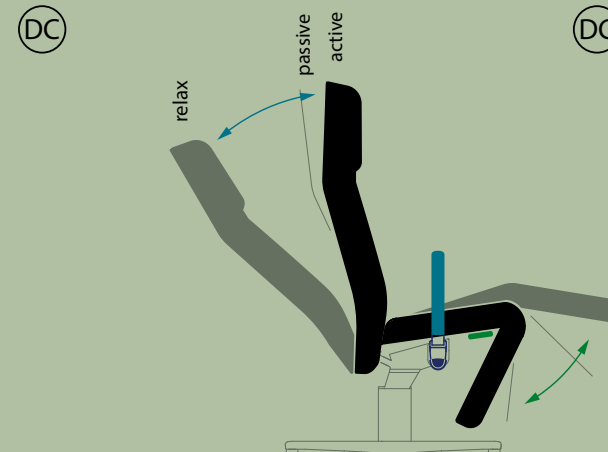

DUO COMFORT SOLO 130°

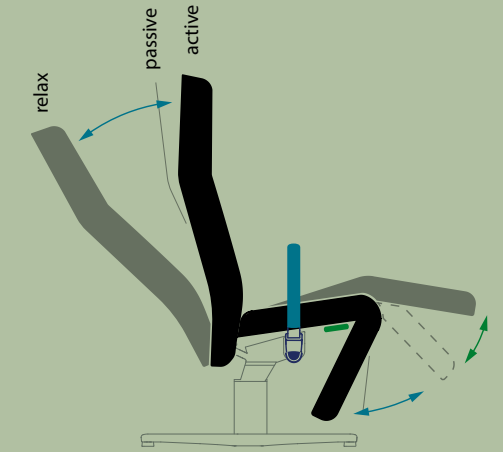

DUO COMFORT SYNCHRO 130°



Pure simplicity. The back and leg rest are **synchronously steplessly adjustable**. From an active or passive sitting posture to an excellent relaxing position.

Pure eenvoud. Rug en beensteun zijn **synchroon traploos verstelbaar**. Van een actieve zithouding tot een uitstekende relaxpositie.

La simplicité à l'état pur. Le dossier et le repose-jambes sont **réglables synchrones sans intervalle**. L'idéal pour passer d'une position assise active ou passive à une position de relaxation exceptionnelle.

Pure Einfachheit. Rückenlehne und Beinablage sind **synchroon stufenlos einstellbar**. Von der aktiven oder passiven Sitzposition in eine hervorragende Relax-Position.

Pure simplicity. The back and leg rest are **synchronously steplessly adjustable**. From an active or passive sitting posture to an excellent sleeping position.

Pure eenvoud. Rug en beensteun zijn **synchroon traploos verstelbaar**. Van een actieve zithouding tot een uitstekende slaappositie.

La simplicité à l'état pur. Le dossier et le repose-jambes sont **réglables synchrones sans intervalle**. L'idéal pour passer d'une position assise active ou passive à une position de sommeil exceptionnelle.

Pure Einfachheit. Rückenlehne und Beinablage sind **synchroon stufenlos einstellbar**. Von der aktiven oder passiven Sitzposition in eine hervorragende Relax-Position.

Easy to use. Duo Comfort Solo guarantees numerous comfort positions where the seat, back and leg rest are **individually steplessly adjustable**.

Gemakkelijk in gebruik. Duo Comfort Solo staat voor tal van zit- en relaxposities. Zit, rug en beensteun zijn apart traploos verstelbaar.

Facile à utiliser. Duo Comfort Solo se porte garant pour différentes positions de confort par lequel l'assise, le dossier et le repose-jambes sont réglables séparément sans intervalle.

Einfach im Gebrauch. Duo Comfort Solo bietet zusätzliche Verstellmöglichkeiten wie das Sitz-, Rücken- und Beinstütze sind stufenlose und separate verstellbar.

Ergonomic. Duo Comfort guarantees numerous comfort positions where the back and leg rest are **separately stepless adjustable**. From an active or passive sitting position to an outstanding sleeping position

Ergonomie. Duo Comfort Synchro staat voor tal van zit- en relaxposities. Rug en beensteun zijn synchroon traploos verstelbaar.

Ergonomie. Duo confort se porte garant pour différentes positions de confort par lequel le dossier et le repose-jambes sont réglables **séparément sans intervalle**. D'une position assise ou passive à une position de sommeil exceptionnelle.

Ergonomie. Duo Comfort bietet zusätzliche Verstellmöglichkeiten wie das **stufenlose und separate** verstellen von Rückenlehne und Beinauflage. Aus einer aktiven oder passiven Sitzposition in einer hervorragenden Schlafposition.

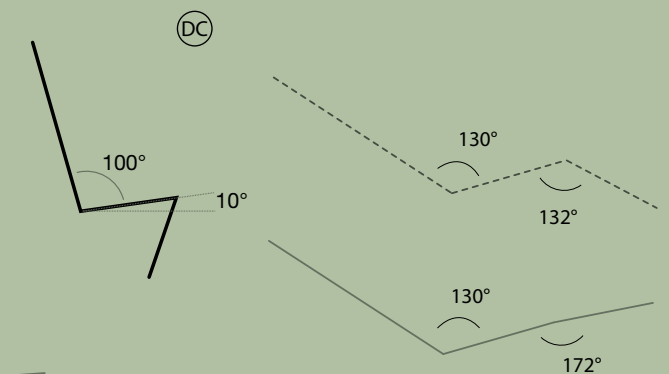
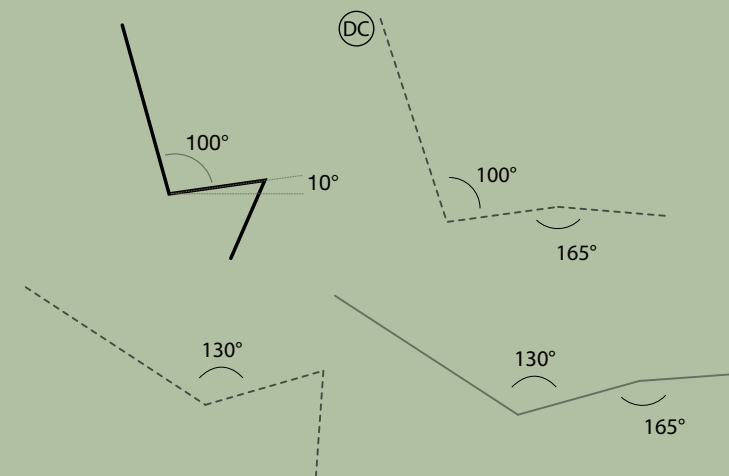
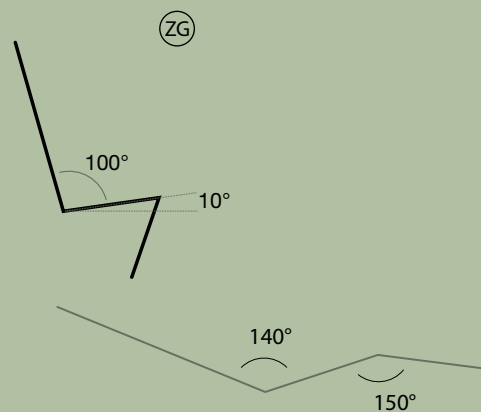
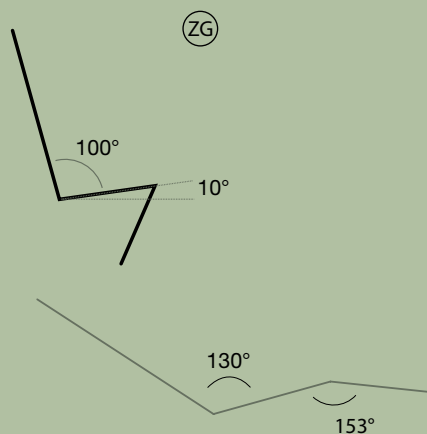

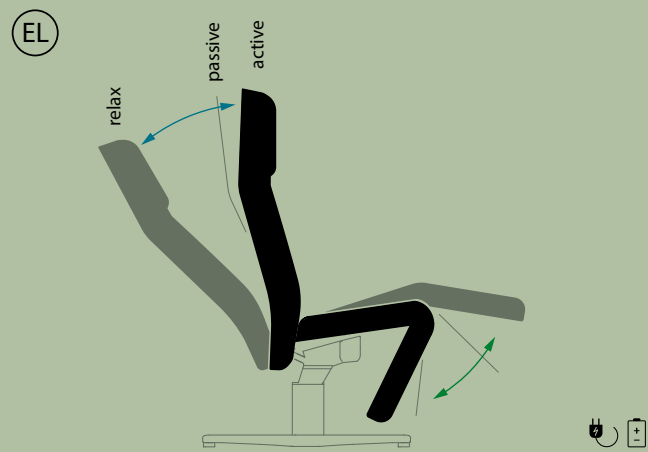

ELECTRIC 125°

Easy to use - Seat, back and leg rest electrically adjustable. Synchronously stepless adjustable or separately adjustable. Optional - removable and rechargeable battery.

Gemakkelijk in gebruik - Zit, rug & beensteun elektrisch verstelbaar, apart of synchroon traploos verstelbaar. Mogelijkheid tot afneembare en oplaadbare batterij.

Facile à utiliser - Assise, dossier et repose-jambes à réglable électrique individuellement ou de manière synchrone en continu. En option - Batterie amovible et rechargeable.

Einfach im Gebrauch - Sitz-, Rücken- & Beinstütze elektrisch verstelbar. Individuell oder synchron stufenlos verstellbar. Möglichkeit einer auswechselbaren und aufladbaren Batterie.

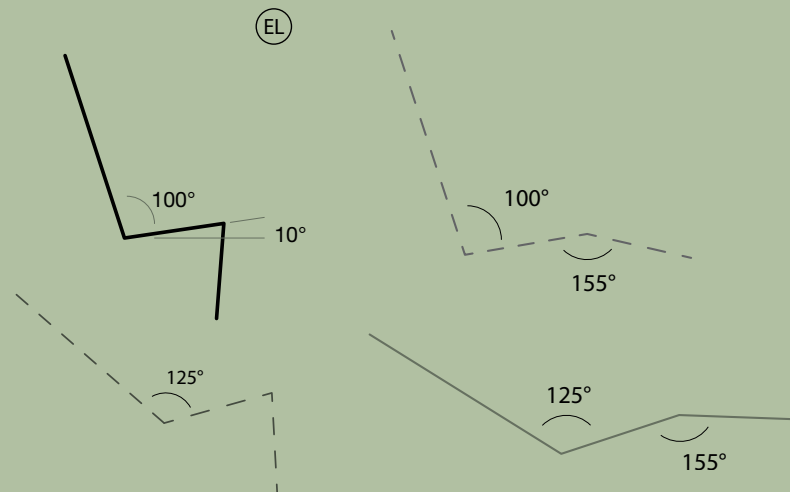

Fusion MODELS



Fusion ARMRESTS*

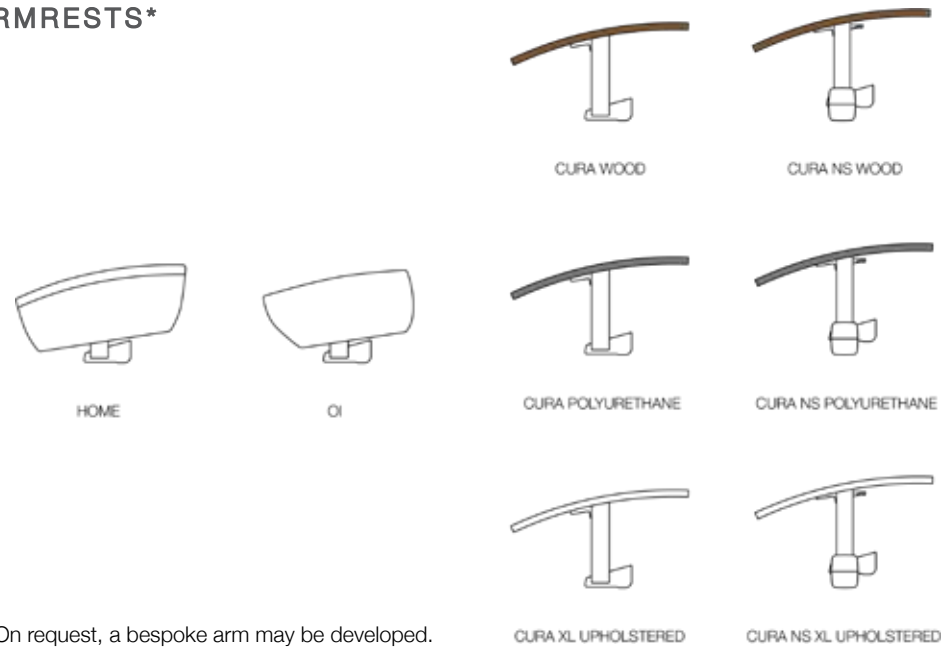

(*) On request, a bespoke arm may be developed.

Fusion INNOVATIVE X-FOOT

48 - 50 - 52 - 54 - 56 - 58 cm seat height

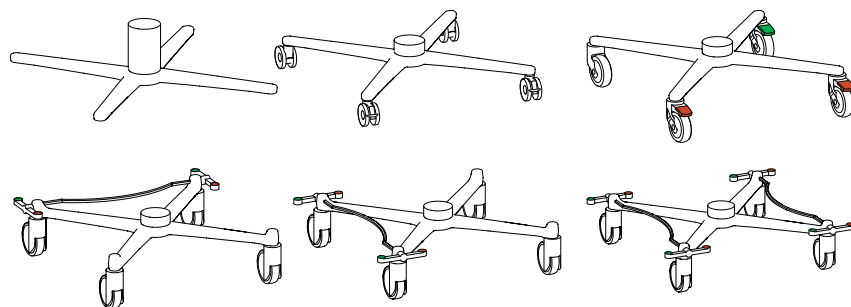

Fusion HANDLES

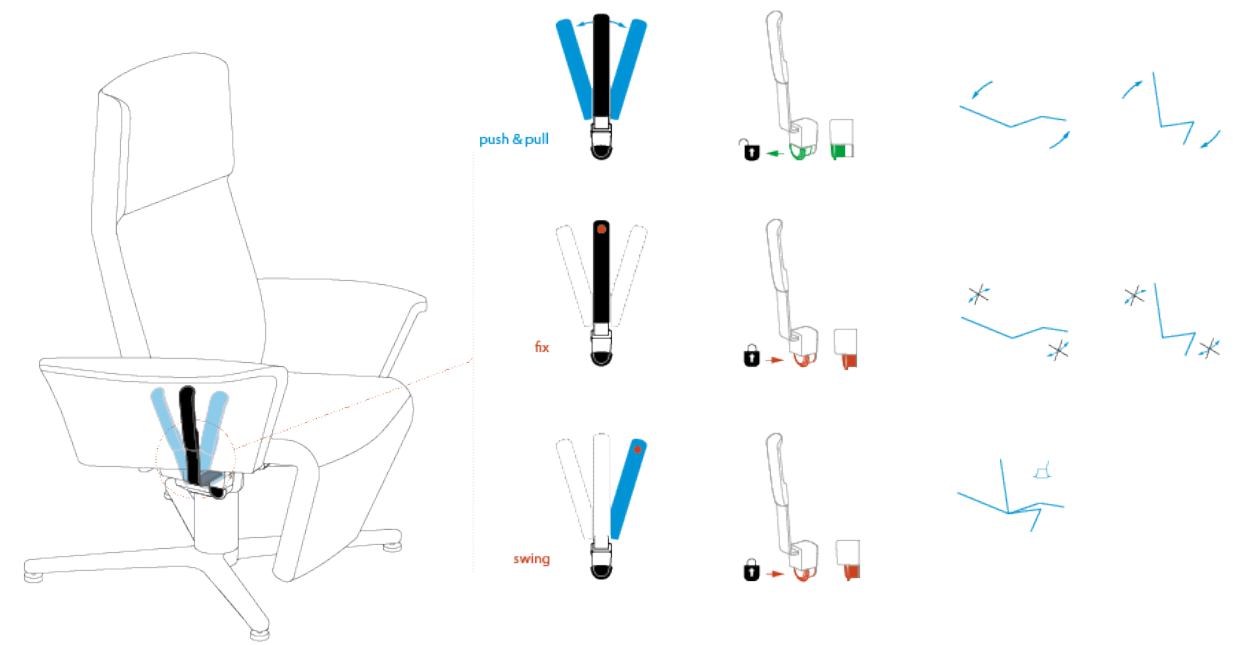

LAGUNA

SCANDINAVIAN INSPIRED, ERGONOMIC DESIGN ...
with superior care comfort.





Laguna Wood with:
QE mechanism
Integrated leg rest
seat not removable
Removable headcushion



Laguna Forest with:
QT mechanism
Removable seat

LAGUNA RECLINING MECHANISMS



VA

Not adjustable

Niet verstelbaar - Non réglable - Nicht verstellbar

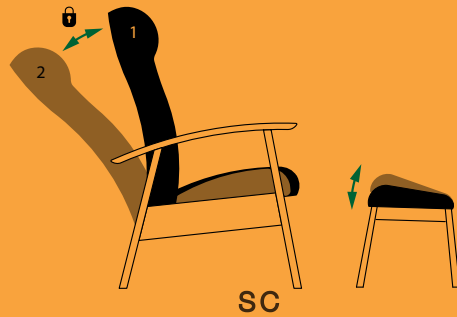

SC

Seat and back adjustable

Zit en rug verstelbaar - Dossier et assise réglables
Sitz und Rücken verstellbar

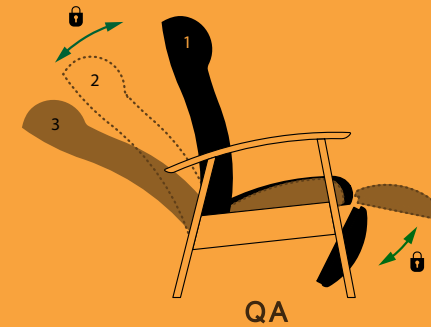

QA

Individual folding lockable leg rest and separately adjustable back.

Afzonderlijk uitklapbare en vergrendelbare beensteun en afzonderlijk verstelbare rug.

Avec repose-jambes rabattable séparément et verrouillable avec dossier réglable séparément.

Separat ausklapbare und feststellbare Beinstütze und mit separat verstellbaren Rücken.

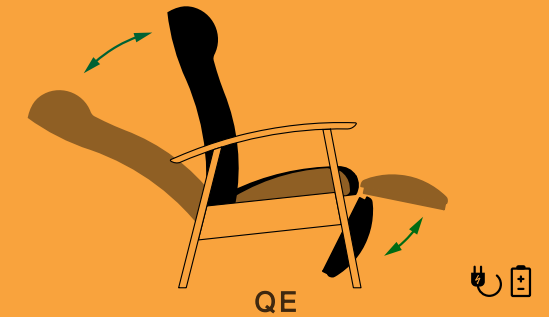

QE

Seat, back and leg rest adjustable, electrically powered.

Zit, rug en beensteun elektrisch verstelbaar.

Dossier, assise et repose-jambes à réglage électrique indépendant.

Sitz, Rücken und Beinstütze einzeln elektrisch verstellbar.

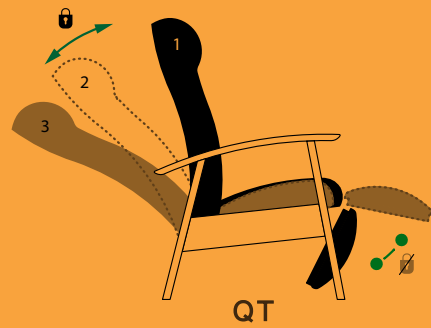
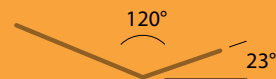
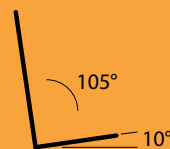
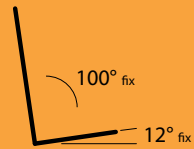

QT

Seat and back adjustable with separately adjustable back

Zit en rug verstelbaar met afzonderlijk verstelbare rug.

Assise et dossier réglables avec dossier réglable séparément.

Sitz und Rücken verstellbar mit separat verstellbaren Rücken.

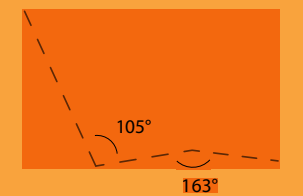
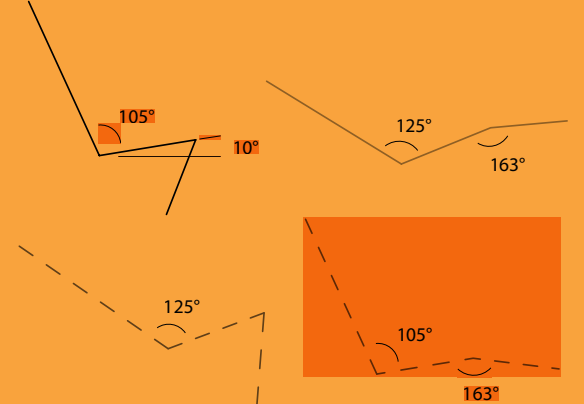
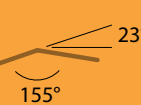
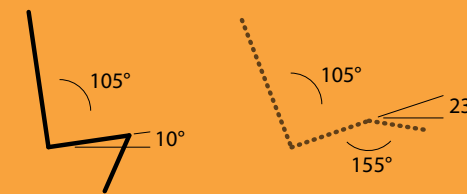
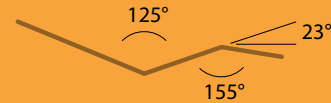
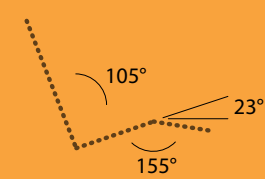
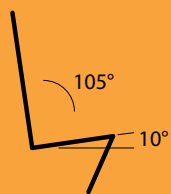

LAGUNA ARMRESTS

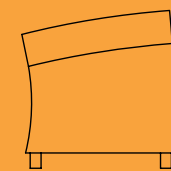

CLASSIC

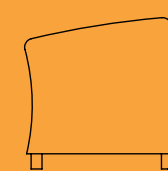

HARMONY

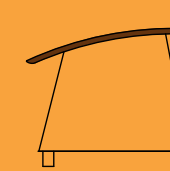

WOOD

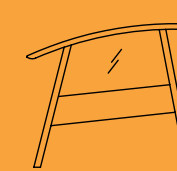

COSY

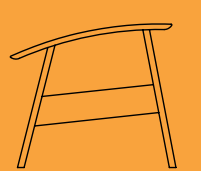

FOREST

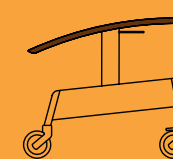

FOREST NS

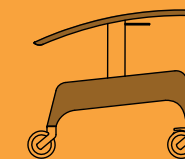

HOSPITAL NS

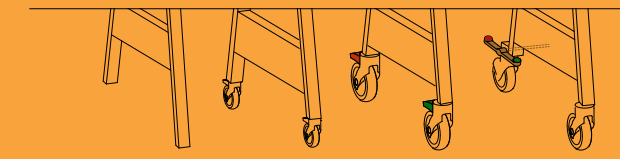

moments ED 02 healthcare furniture \ 41



LAGUNA MODELS



LAGUNA CLASSIC



LAGUNA CLASSIC WHEELS Ø 75



LAGUNA CLASSIC WHEELS Ø 125



LAGUNA COSY WHEELS Ø 125



LAGUNA COSY WHEELS Ø 125
CENTRAL BRAKE



LAGUNA FOREST



LAGUNA HARMONY



LAGUNA HARMONY WHEELS Ø 75



LAGUNA HARMONY WHEELS Ø 125



LAGUNA FOREST WHEELS Ø 75



LAGUNA FOREST WHEELS Ø 125



LAGUNA FOREST WHEELS Ø 125
CENTRAL BRAKE



LAGUNA WOOD



LAGUNA WOOD WHEELS Ø 75



LAGUNA WOOD WHEELS Ø 125



LAGUNA FOREST NS Ø 125



LAGUNA FOREST NS WHEELS Ø 125
CENTRAL BRAKE



LAGUNA COSY



LAGUNA COSY WHEELS Ø 75



LAGUNA HOSPITAL NS WHEELS Ø 125



LAGUNA HOSPITAL NS WHEELS Ø 125
CENTRAL BRAKE



ECHO

BUDGET-FRIENDLY, EASY TO USE, SIMPLE ... and comfortable.





Echo Cosy with SR Mechanism

ECHO RECLINING MECHANISMS



VA

Not adjustable

Niet verstelbaar - Non réglable - Nicht verstellbar

SR



SR

Adjustable seat, back and leg rest with automatically folding leg rest. Additional separate stepless adjustable back. Includes posture correction feature.

Zitting, rug en beensteun verstelbaar met automatisch uitklapbare beensteun. Bijkomend afzonderlijk traploze, verstelbare rug. Voorzien van zitcorrectie.

Siège, dossier et repose-jambes réglables avec repose-jambes escamotable automatiquement. Dossier réglable et verrouillable séparément et en continu. Avec correction d'assise.

Verstellbarer Sitz, Rücken und Beinauflage mit automatisch ausklappender Beinauflage. Zusätzlich separat stufenlos verstellbare Rückenlehne. Ausgestattet mit Sitzkorrektur.

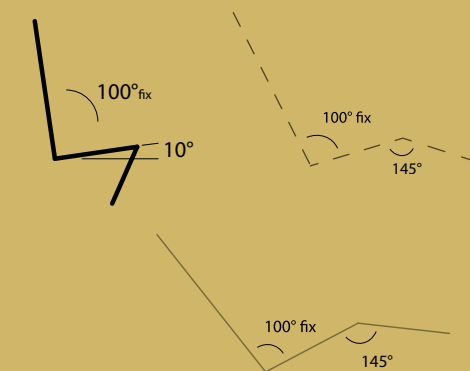
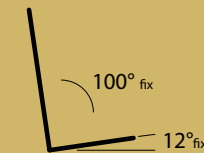

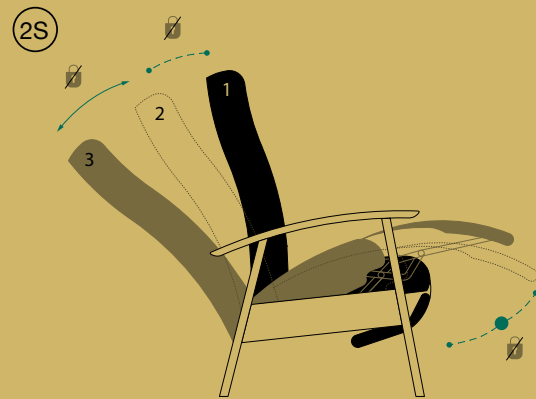

2S

Adjustable seat, back and leg rest with automatically folding leg rest. Additional separate stepless adjustable back. Includes posture correction feature.

Zit en rug zijn verstelbaar met een afzonderlijk verstelbare rug. Automatisch mee uitklapbare beensteun. Voorzien van zitcorrectie.

Siège, dossier et repose-jambes réglables avec reposejambes escamotable automatiquement. Avec correction d'assise.

Verstellbarer Sitz, Rücken und Beinauflage mit automatisch ausklappenden Beinauflage. Ausgestattet mit Sitzkorrektur.

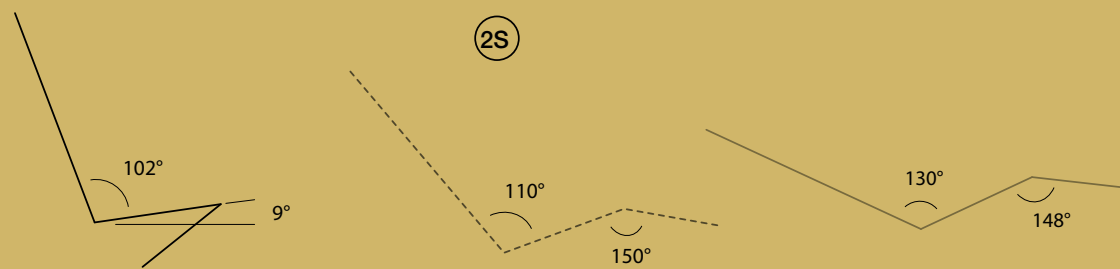

CLASSIC

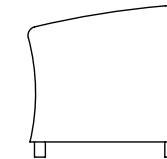

HARMONY

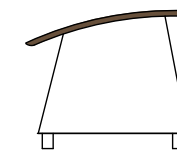

WOOD

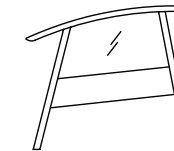

COSY

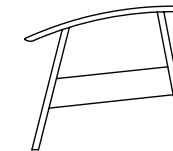

FOREST

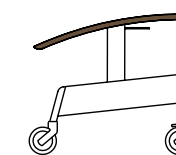

FOREST NS

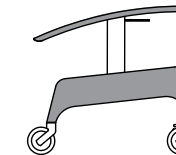

HOSPITAL NS

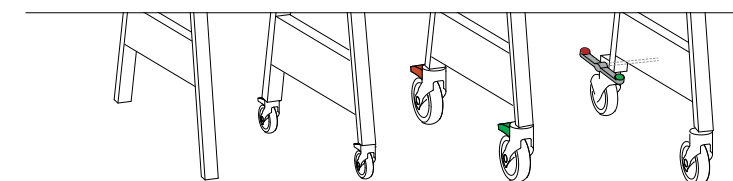

ECHO MODELS



ECHO CLASSIC



ECHO CLASSIC WHEELS Ø 75



ECHO CLASSIC WHEELS Ø 125



ECHO COSY WHEELS Ø 125



ECHO COSY WHEELS Ø 125
CENTRAL BRAKE



ECHO FOREST



ECHO HARMONY



ECHO HARMONY WHEELS Ø 75



ECHO HARMONY WHEELS Ø 125



ECHO FOREST WHEELS Ø 75



ECHO FOREST WHEELS Ø 125



ECHO FOREST WHEELS Ø 125
CENTRAL BRAKE



ECHO WOOD



ECHO WOOD WHEELS Ø 75



ECHO WOOD WHEELS Ø 125



ECHO FOREST NS Ø 125



ECHO FOREST NS WHEELS Ø 125
CENTRAL BRAKE



ECHO COSY



ECHO COSY WHEELS Ø 75



ECHO HOSPITAL NS WHEELS Ø 125



ECHO HOSPITAL NS WHEELS Ø 125
CENTRAL BRAKE



COSMO

UNIVERSAL DESIGN ... comfort for all.



COSMO MODELS

Universal contemporary design. Created to offer perfect seating comfort to be enjoyed now, and appreciated even more later on in life. The matching footrest completes the look.



Universeel design, hedendaagse vormgeving. Optimaal comfort voor nu, met onopvallend zorgcomfort voor later. Een bijpassende voetenbank maakt de stoelzetel compleet

Design universel et un look contemporain. Un confort optimal de l'instant, avec un confort de soins discret pour plus tard. Un repose-pieds assorti au fauteuil pour un ensemble complet.

Universellen und zeitgenössischen Design. Sofortiger optimaler Komfort mit unauffälligem Pflegekomfort für später. Passende Fußbank zum Stuhlsessel ergänzt den Stuhl optimal.



COSMO HIGH BACK & WING ARMREST WOODEN LEGS



COSMO HIGH BACK & SMALL ARMREST WOODEN LEGS



COSMO LOW BACK & WING ARMREST WOODEN LEGS



COSMO LOW BACK & SMALL ARMREST WOODEN LEGS



COSMO FOOTREST WOODEN OR METAL LEGS



COSMO HIGH BACK & WING ARMREST METAL LEGS



COSMO HIGH BACK & SMALL ARMREST METAL LEGS



COSMO LOW BACK & WING ARMREST METAL LEGS



COSMO LOW BACK & SMALL ARMREST METAL LEGS

VENTO

Classic lineage combined with
the most modern seating comfort.



VENTO RECLINING MECHANISMS

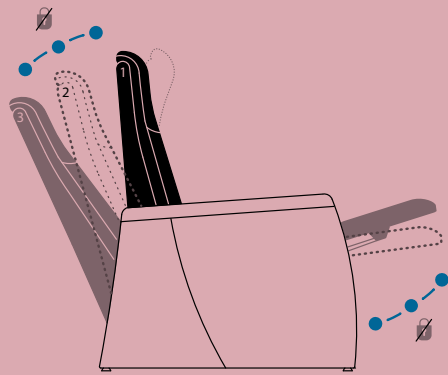

VE

Manually adjustable, standard with manual head adjustment, equipped with extendible footrest, back and seat with (slightly) variable inclination angle.

Manueel verstelbaar, standaard met manuele hoofdverstelling, voorzien van uitklapbare beensteun, rug en zit met (licht) variabele inclinatiehoek.

Réglage manuel, ajustement tête réglable manuellement, équipé de support des jambes escamotable, dossier et assise avec angle d'inclinaison (légèrement) variable.

Manuell verstellbar, standard mit manueller Kopfverstellung, ausgestattet mit ausklappbarer Beinstütze, Rückenlehne und Sitzfläche mit (leicht) variablem Neigungswinkel.

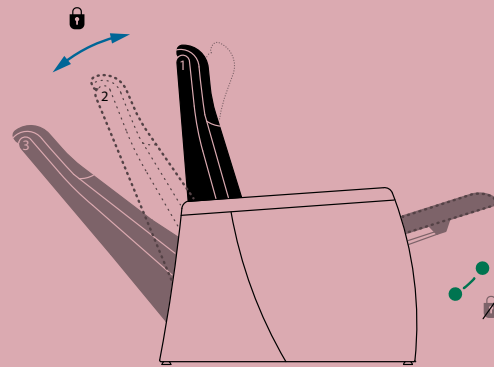

MAG

Manually adjustable, standard with manual head adjustment, equipped with extendible footrest, back adjustable with a gas spring, back and seat with variable inclination angle.

Manueel verstelbaar, standaard met manuele hoofdverstelling, voorzien van uitklapbare beensteun, rug met gasveer verstelbaar, rug en zit met variabele inclinatiehoek.

Réglage manuel, standard avec réglage manuel de la tête, équipé de support des jambes escamotable, dossier réglable avec un ressort à gaz, dossier et assise avec angle d'inclinaison variable.

Manuell verstellbar, standard mit manueller Kopfverstellung, ausgestattet mit ausklappbarer Beinstütze, Rückenlehne mit einer Gasfeder verstellbar, Rückenlehne und Sitzfläche mit variablem Neigungswinkel.

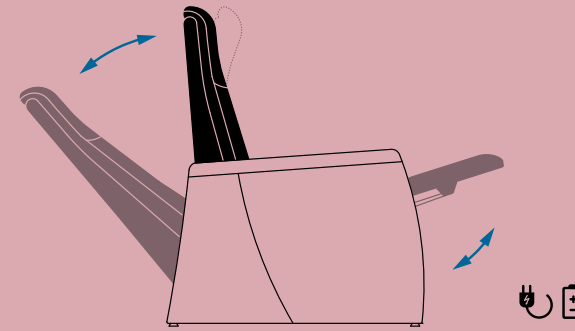

EL1

Electrically adjustable, with manual headrest adjustment as standard, with fold-out leg rest, back and leg adjustable in one single motion, back and seat with variable inclination angle, 1 motor.

Elektrisch verstelbaar, standaard met manuele hoofdverstelling, voorzien van uitklapbare beensteun, been en rug in één beweging verstelbaar, rug en zit met variabele inclinatiehoek, 1 motor.

Réglage électrique, réglage manuel de la tête de série, avec repose-jambes escamotable, jambes et dossier réglables et une seule fois, dossier et assise avec inclinaison variable, 1 moteur.

Elektrisch verstellbar, serienmäßig mit manueller Kopfverstellung, mit klappbarer Beinstütze, Bein- und Rückenverstellung in einem Arbeitsgang, Rücken und Sitz mit variablem Neigungswinkel, 1 Motor.

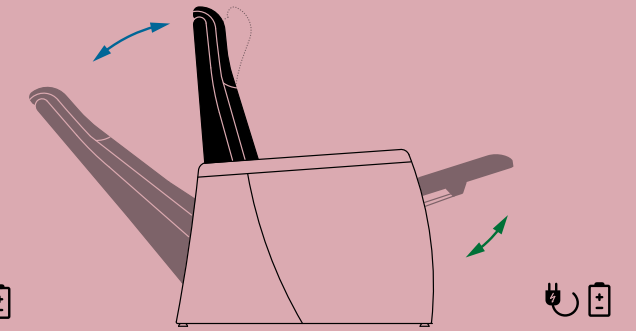

EL2

Electrically adjustable, with manual headrest adjustment as standard, with fold-out leg rest, back and leg individually adjustable, back and seat with variable inclination angle, 2 motors.

Elektrisch verstelbaar, standaard met manuele hoofdverstelling, voorzien van uitklapbare beensteun, been en rug afzonderlijk verstelbaar, rug en zit met variabele inclinatiehoek, 2 motoren.

Réglage électrique, réglage manuel de la tête de série, avec repose-jambes escamotable, jambes et dossier réglables indépendamment, dossier et assise avec inclinaison variable, 2 moteurs.

Elektrisch verstellbar, serienmäßig mit manueller Kopfverstellung, ausgestattet mit klappbarer Beinauflage, Bein- und Rückenlehne separat verstellbar, Rücken und Sitz mit variablem Neigungswinkel, 2 Motoren.

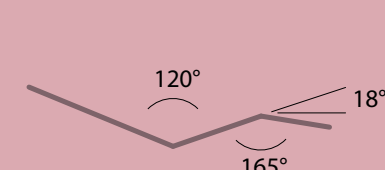
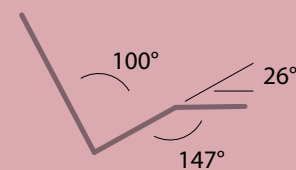
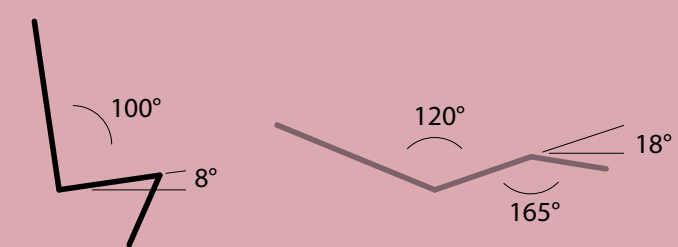
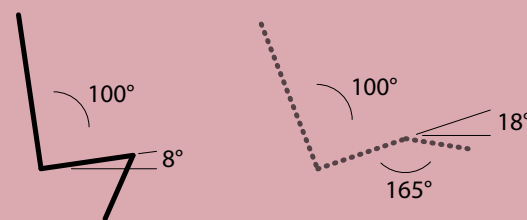
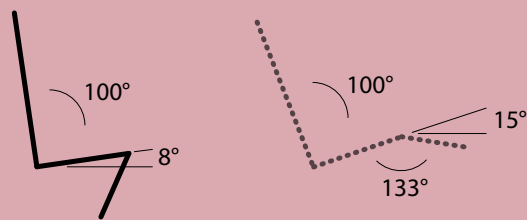

BREZZA

ATTRACTIVE DESIGN ... with a range of possibilities.



BREZZA RECLINING MECHANISMS

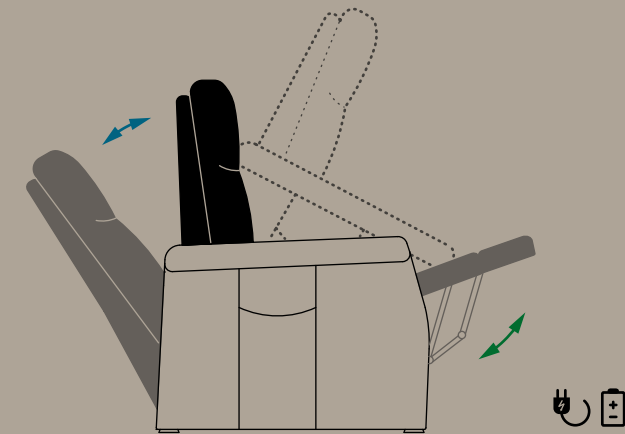

Electrically adjustable, back and seat with variable inclination angle, standard with separated control, stand-up assistance, 2 motors.

Elektrisch verstelbaar, rug en zit met variabele inclinatiehoek, standaard met losse handbediening, sta-op-functie, 2 motoren.

Réglage électrique, dossier et assise avec angle d'inclinaison variable, standard avec opération manuelle séparée, aide automatique à la mise en position debout, 2 moteurs.

Elektrisch verstelbaar, Rückenlehne und Sitzfläche mit variablem Neigungswinkel, Standard mit separater Bedienung, Aufstehfunktion, 2 Motoren.

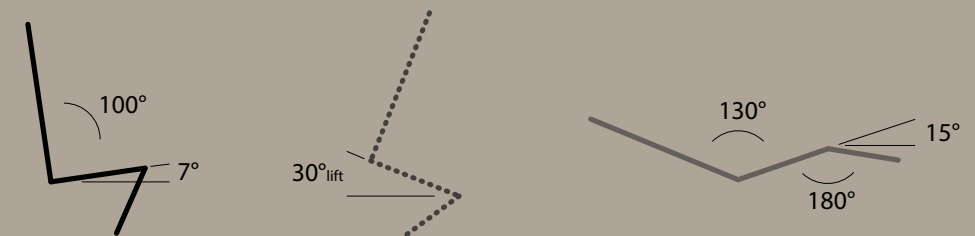

ZETA

COMFORT and COSINESS



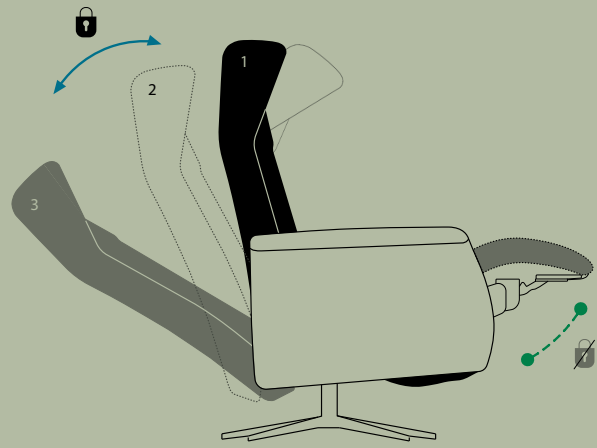

MAG

Manually adjustable, standard with manual head adjustment, equipped with extendible footrest, back adjustable with a gas spring, back and seat with variable inclination angle.

Manueel verstelbaar, standaard met manuele hoofdverstelling, voorzien van uitklapbare beensteun, rug met gasveer verstelbaar, rug en zit met variabele inclinatiehoek.

Réglage manuel, standard avec réglage manuel de la tête, équipé de support des jambes escamotable, dossier réglable avec un ressort à gaz, dossier et assise avec angle d'inclinaison variable.

Manuell verstellbar, standard mit manueller Kopfverstellung, ausgestattet mit ausklappbarer Beinstütze, Rückenlehne mit einer Gasfeder verstellbar, Rückenlehne und Sitzfläche mit variablem Neigungswinkel.



EL2

Electrically adjustable, standard with manual head adjustment, equipped with extendible legrest, leg and back adjustable separately, back and seat with variable inclination angle, 2 motors.

Elektrisch verstelbaar, standaard met manuele hoofdverstelling, voorzien van uitklapbare beensteun, been en rug afzonderlijk verstelbaar, rug en zit met variabele inclinatiehoek, 2 motoren.

Réglage électrique, standard avec réglage manuel de la tête, équipé de support des jambes escamotable, jambes et dossier réglable séparément, dossier et assise avec angle d'inclinaison variable, 2 moteurs.

Elektrisch verstellbar, standard mit manueller Kopfverstellung, ausgestattet mit ausklappbarer Beinstütze, Beinstütze und Rücken getrennt verstellbar, Rückenlehne und Sitzfläche mit variablem Neigungswinkel, 2 Motoren.

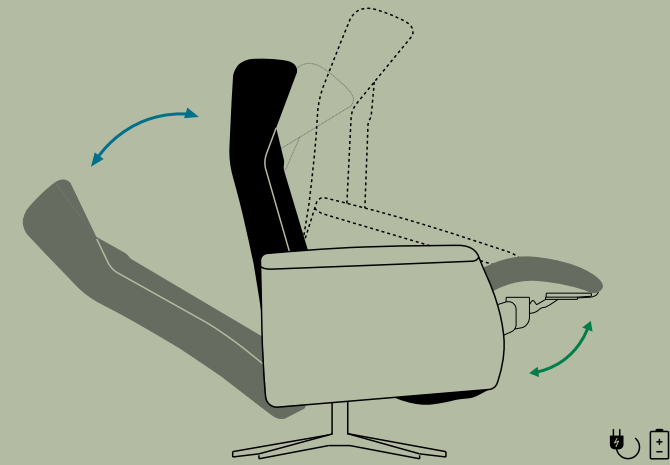

PO1

Electrically adjustable, with fold-out leg support, leg and back individually adjustable, back and seat with variable inclination angle, 3 motors. Stand-up function, rotation blocking during lift function, separate built-in operation.

Elektrisch verstelbaar, voorzien van uitklapbare beensteun, been en rug afzonderlijk verstelbaar, rug en zit met variabele inclinatiehoek, 3 motoren. Sta-op functie, draaiblokkering bij liftfunctie, apart ingebouwde bediening.

Réglable électriquement, équipé d'un repose-jambes escamotable, jambes et dossier réglables séparément, dossier et assise avec angle d'inclinaison variable, 3 moteurs. Assistance à la mise en position debout, blocage de rotation pour l'assistance à la mise en position debout, commande intégrée séparément.

Elektrisch verstellbar, mit klappbarer Beinauflage, Bein- und Rückenlehne separat verstellbar, Rücken und Sitz mit variablem Neigungswinkel, 3 Motoren. Aufstehfunktion, Drehverriegelung beim Heben, separat eingebaute Bedienelemente.

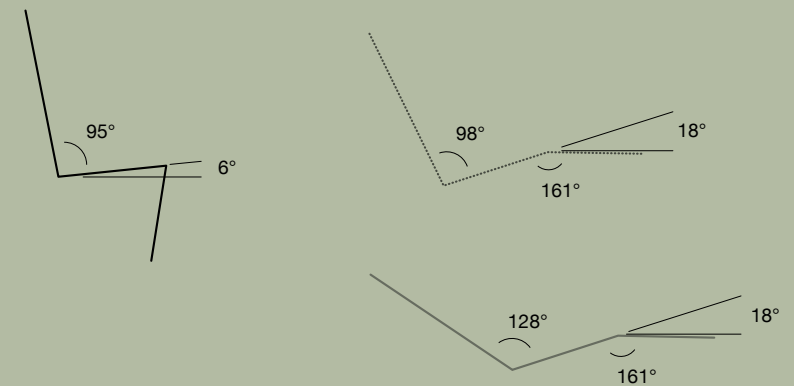
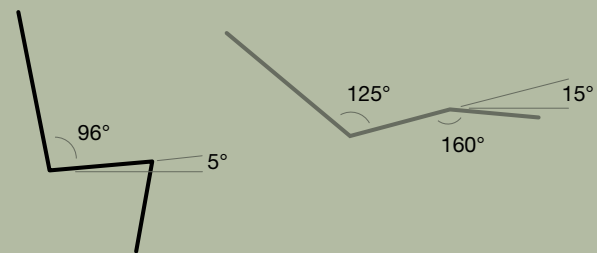
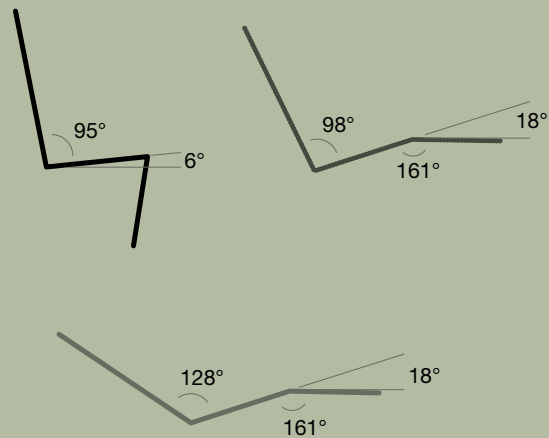

NOVA

STYLISH ... architectural.



NOVA RECLINING MECHANISMS

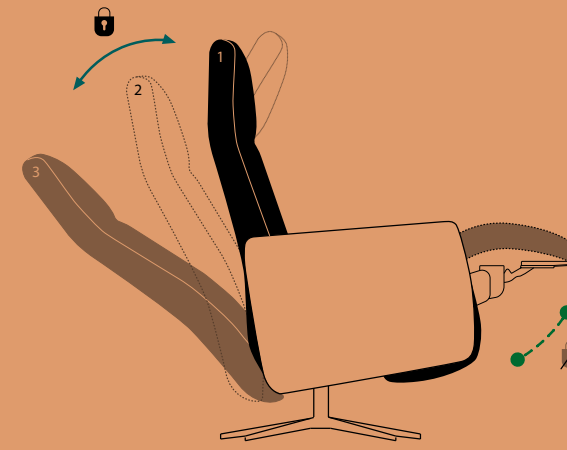

MAG

Manually adjustable, standard with manual head adjustment, equipped with extendible footrest, back adjustable with a gas spring, back and seat with variable inclination angle.

Manueel verstelbaar, standaard met manuele hoofdverstelling, voorzien van uitklapbare beensteun, rug met gasveer verstelbaar, rug en zit met variabele inclinatiehoek.

Réglage manuel, standard avec réglage manuel de la tête, équipé de support des jambes escamotable, dossier réglable avec un ressort à gaz, dossier et assise avec angle d'inclinaison variable.

Manuell verstellbar, standard mit manueller Kopfverstellung, ausgestattet mit ausklappbarer Beinstütze, Rückenlehne mit einer Gasfeder verstelbar, Rückenlehne und Sitzfläche mit variablem Neigungswinkel.



EL2

Electrically adjustable, standard with manual head adjustment, equipped with extendible legrest, leg and back adjustable separately, back and seat with variable inclination angle, 2 motors.

Elektrisch verstelbaar, standaard met manuele hoofdverstelling, voorzien van uitklapbare beensteun, been en rug afzonderlijk verstelbaar, rug en zit met variabele inclinatiehoek, 2 motoren.

Réglage électrique, standard avec réglage manuel de la tête, équipé de support des jambes escamotable, jambes et dossier réglable séparément, dossier et assise avec angle d'inclinaison variable, 2 moteurs.

Elektrisch verstellbar, standard mit manueller Kopfverstellung, ausgestattet mit ausklappbarer Beinstütze, Beinstütze und Rücken getrennt verstellbar, Rückenlehne und Sitzfläche mit variablem Neigungswinkel, 2 Motoren.

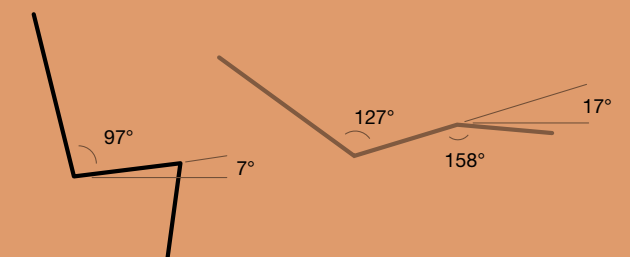
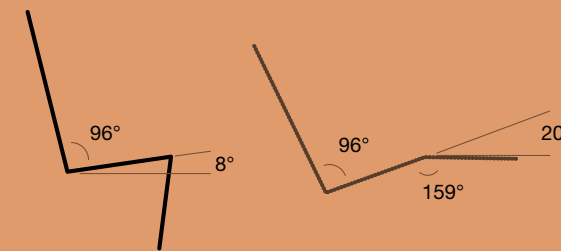

STANDARD MODEL



| | Fuzion | | | | | LAGUNA | | | | | | | ECHO | | | | | | | |
|--|--------|------|-------|------|---------|---------|---------|------|------|--------|-----------|-------------|---------|---------|------|------|--------|-----------|-------------|---|
| | Ino | | | | | CLASSIC | HARMONY | WOOD | COSY | FOREST | FOREST NS | HOSPITAL NS | CLASSIC | HARMONY | WOOD | COSY | FOREST | FOREST NS | HOSPITAL NS | |
| | HOME | CASA | LIGNA | CURA | CURA NS | | | | | | | | | | | | | | | |
| Retractable footrest / Inschuifbare voetensteun / Repose-pieds rétractable / Ausziehbare Fußstützer - 1 | | | | | | | | | | | | | | | | | | | | |
| Removable seat / Uitneembare zitting / Assise amovible / Sitz abnehmbar - 2 | | | | | | | | | | | | | | | | | | | | |
| Back with integrated headrest / Rug met geïntegreerde hoofdsteun / Dossier avec appui-tête intégré / Rückenlehne mit integrierte Kopfstütze - 3 | ■ | ■ | ■ | ■ | ■ | ■ | ■ | ■ | ■ | ■ | ■ | ■ | | | | | | | | |
| Height-adjustable armrests / Neerschuijbare armleggers / Accoudoirs amovibles / Höhenverstellbare Armlehne - 4 | | | | | ■ | | | | | | | | | | | | | | | |
| Integrated comfort leg rest, seat removable, hygienegap / Geïntegreerde comfort beensteun, zitting niet uitneembaar, kruimelgoot / Repose-jambes confort intégré, revêtement en 1 partie, goulotte / Komfort Beinauflage, Sitz nicht abnehmbar, Hygiene-Lücke - 5 | ■ | ■ | ■ | ■ | ■ | | | | | | | | | | | | | | | |
| Seating Heights / Zithoogte / Hauteur d'assise / Sitzhöhe 46 - 48 - 50 - 52 - 54 - 56 cm - 6 | ■ | ■ | ■ | ■ | ■ | | | | | | | | | | | | | | | |
| Ergonomic synthetic armrest / Ergonomische kunststof duwarm / Poignée de guidage ergonomique en matière synthétique / Ergonomische Kunststoff-Schiebügel - 7 | ■ | ■ | ■ | ■ | ■ | | | | | | | | | | | | | | | |
| Long "CARE" handles / Lange "CARE" bedieningshendels / Pognées longues "CARE" / Bedienungshebel "CARE" lang - 8 | ■ | ■ | ■ | ■ | | | | | | | | | | | | | | | | |
| Small handles / Korte bedieningshendels / Poignées courtes / Bedienungshebel kurz - 9 | ■ | ■ | ■ | ■ | | | | | | | | | | | | | | | | |
| Horizontal handles outside for adjustable armrests / Horizontale bedieningshendels aan buitenzijde voor neerschuijbare arm / Poignées horizontales à l'extérieur pour les accoudoirs amovibles / Horizontale Bedienungshebel auf der Aussenseite für höhenverstellbare Armlehne - 10 | | | | | ■ | | | | | | | | | | | | | | | |
| Fixture for dining tray / Voorziening voor eettafel / Porte-tablette repas / Vorrichtung für Esstablett - 11 | | | ■ | ■ | ■ | | | ■ | ■ | ■ | ■ | ■ | | | ■ | ■ | ■ | ■ | ■ | ■ |
| Integrated manual tiltable headrest / Geïntegreerde manuele hoofdverstelling / Appui-tête intégré ajustable manuellement / Integrierte manuell schwenkbare Kopfstütze - 12 | ■ | ■ | ■ | ■ | ■ | | | | | | | | | | | | | | | |

OPTIONS



| | Fuzion | | | | | LAGUNA | | | | | | | | ECHO | | | | | | |
|---|--------|------|-------|------|---------|---------|---------|------|------|--------|--------|----------|---------|---------|------|------|--------|--------|----------|--|
| | HOME | CASA | LIGNA | CURA | CURA NS | CLASSIC | HARMONY | WOOD | COSY | FOREST | FOREST | HOSPITAL | CLASSIC | HARMONY | WOOD | COSY | FOREST | FOREST | HOSPITAL | |
| Retractable footrest / Inschuifbare voetensteun / Repose-pieds rétractable / Ausziehbare Fußstütze - 1 | ■ | ■ | ■ | ■ | ■ | ■ | ■ | ■ | ■ | ■ | | | ■ | ■ | ■ | ■ | ■ | | | |
| 2 shifting castors on the rear legs / 2 verplaatsingswielen op de achterse poten / 2 roulettes de déplacement sur les pieds arrière / 2 Transportrollen an den hinteren Beinen - 2 | ■ | ■ | ■ | ■ | ■ | ■ | ■ | ■ | ■ | ■ | | | | | | ■ | ■ | ■ | ■ | |
| Fixations brackets / Fixatiebeugels / Support de fixation / Fixierungsbügel - 3 | ■ | ■ | ■ | ■ | ■ | ■ | ■ | ■ | ■ | ■ | ■ | ■ | ■ | ■ | ■ | ■ | ■ | ■ | ■ | |
| Supply for suspension oxygen bottle / Voorziening zuurstoffeshouder / Approvisionnement pour porte bouteille d'oxygène / Versorgung für Sauerstoffflaschenhalterung - 4 | ■ | ■ | ■ | ■ | ■ | ■ | ■ | ■ | ■ | ■ | ■ | ■ | | | | | | | | |
| Provision for suspension dining tray / Voorziening voor opberging kunststof eettafel / Pré-équipement pour fixation porte-tablette repas / Vorrichtung für Kunststoff-Serviertablett - 5 | | | ■ | ■ | ■ | | | ■ | ■ | ■ | ■ | ■ | | | ■ | ■ | ■ | ■ | ■ | |
| Hygienic finish trim for back / Hygiënische afwerking garniering voor rug / Finition hygiénique pour le garnissage du dossier / Hygienische Verarbeitung für Rückenlehne - 6 | ■ | ■ | ■ | ■ | ■ | | | | | | | | | | | | | | | |
| Provision for fixed IV pole with 2 hooks / Voorziening voor vaste serumhouder met 2 haken / Pré-équipement pour porte-sérum fixe avec 2 crochets / Vorrichtung für festen Infusionshalter mit zwei Haken - 7 | ■ | ■ | ■ | ■ | ■ | | | ■ | ■ | ■ | ■ | ■ | | | ■ | ■ | ■ | ■ | ■ | |
| Provision for IV pole with 4 hooks / Voorziening voor uitschuifbare serumhouder met 4 haken / Pré-équipement pour porte-sérum télescopique avec 4 crochets / Vorrichtung für ausziehbaren Infusionshalter mit 4 Haken - 8 | ■ | ■ | ■ | ■ | ■ | | | | | | | | | | | | | | | |
| Provision for abduction belt on dining tray / Voorziening voor abductieklos op eettafel / Pré-équipement pour selle d'abduction sur tablette de repas / Vorrichtung für Abduktionskeil am Serviertablett - 9 | | | ■ | ■ | ■ | | | ■ | ■ | ■ | ■ | ■ | ■ | ■ | ■ | ■ | ■ | ■ | ■ | |
| Provision for coffee table / Voorziening voor koffietafel / Pré-équipement pour table à café / Vorrichtung für Kaffeetisch - 10 | ■ | ■ | ■ | ■ | ■ | | | | | | | | | | | | | | | |
| Integrated fixation belt / Geïntegreerde fixatieriem / Centure de fixation intégrée / Integrierter Fixierungsgurt - 11 | ■ | ■ | ■ | ■ | ■ | ■ | ■ | ■ | ■ | ■ | ■ | ■ | ■ | ■ | ■ | ■ | ■ | ■ | ■ | |
| Half upholstered armrest / Half beklede armsteun / Accoudoir partiellement garni / Halb gepolsterte Armlehne - 12 | | | ■ | ■ | ■ | | | ■ | ■ | ■ | ■ | | | | ■ | ■ | ■ | ■ | | |
| Fully upholstered armrest / Geheel beklede armsteun / Accoudoir totalement garni / Komplett gepolsterte Armlehne - 13 | | | ■ | ■ | ■ | | | ■ | ■ | ■ | ■ | | | | ■ | ■ | ■ | ■ | | |
| Provision for elevating orthopedic leg rest / Voorziening voor verstelbare orthopedische beensteun / Pré-équipement pour repose-jambes orthopédique réglable / Vorrichtung orthopädischen Beinstütze - 14 | ■ | ■ | ■ | ■ | ■ | | | | | | | | | | | | | | | |

OPTIONS



| | Fuzion | | | | | LAGUNA | | | | | | | ECHO | | | | | | |
|---|--------|---|---|---|---|---------|---------|------|------|--------|-----------|-------------|---------|---------|------|------|--------|-----------|-------------|
| | Ino | | | | | CLASSIC | HARMONY | WOOD | COSY | FOREST | FOREST NS | HOSPITAL NS | CLASSIC | HARMONY | WOOD | COSY | FOREST | FOREST NS | HOSPITAL NS |
| Removable and rechargeable battery / Uitneembare en oplaadbare batterij / Batterie amovible et rechargeable / Abnehmbarer und wiederaufladbarer Akku - 15 | ■ | ■ | ■ | ■ | ■ | | | | | | | | | | | | | | |
| Provision for narrowing cushion legs / Voorziening voor anatomische reductor beensteun / Pré-équipement réducteur anatomique / Vorrichtung Verkleinerungskisse Beinauflage - 16 | ■ | ■ | ■ | ■ | ■ | | | | | | | | | | | | | | |
| Removable headrest / Afneembaar hoofdeinde / Appuie-tête amovible / Abnehmbare Kopfstütze - 17 | ■ | ■ | ■ | ■ | ■ | ■ | ■ | ■ | ■ | ■ | ■ | ■ | | | | | | | |
| Provision for multi directional anatomically shaped armrest / Voorziening voor multidirectionele anatomisch gevormde armleuning / Pré-équipement pour accoudoir multidirectionelle de forme anatomique / Vorrichtung für Anatomisch geformte, multidirektionale Armlehne - 18 | | | | | ■ | | | | | | | | | | | | | | |
| Seat equipped with visco elastic foam / Zitting voorzien van visco-elastisch schuim / Assise équipé de mousse visco élastique / Sitz ausgestattet mit viskoelastischem Schaum - 19 | | | | | | ■ | ■ | ■ | ■ | ■ | ■ | ■ | | | | | | | |
| Wider leg rest / Breidere gevormde beensteun / Repose-jambes plus large / Breitere, vorgeformte Beinauflage - 20 | | | | | | ■ | ■ | ■ | ■ | ■ | ■ | ■ | | | | | | | |
| Integrated leg rest, seat not removable / Geïntegreerde beensteun, zitting niet uitneembaar / Repose-jambes intégré en 1 partie, assise non amovible / Integrierte Beinauflage, Sitz nicht abnehmbar - 21 | | | | | | ■ | ■ | ■ | ■ | ■ | ■ | ■ | | | | | | | |
| Adjustable shoulder support / In hoogte verstelbare schoudersteun / Oreillettes réglable / Höhenverstellbare Schulterstützen - 22 | | | | | | ■ | ■ | ■ | ■ | ■ | ■ | ■ | | | | | | | |
| Central brake at the rear / Centrale rem achteraan / Frein central à l'arrière / Zentralbremse hinten - 23 | | | | | | | | | ■ | ■ | ■ | ■ | ■ | ■ | ■ | ■ | ■ | ■ | ■ |
| Synthetic push bar / Kunststof duwbeugel / Guidon en matière synthétique / Schiebearm aus Kunststoff - 24 | | | | | | ■ | ■ | ■ | ■ | ■ | | | ■ | ■ | ■ | ■ | | | |
| Permanent battery with electrical version / Vaste batterij bij elektrische uitvoering / Batterie permanente sur version électrique / Feste Batterie bei elektrischer Ausführung - 25 | | | | | | ■ | ■ | ■ | ■ | ■ | ■ | ■ | | | | | | | |
| Flat back / Vlakke rug / Dossier non préformé / Flache Rückenlehne - 26 | | | | | | ■ | ■ | ■ | ■ | ■ | ■ | ■ | | | | | | | |
| Suspension removable head / Ophanging hoofdeinde / Fixation pour appuie-tête / Aufhängungsmöglichkeit für Kopfende - 27 | | | | | | ■ | ■ | ■ | ■ | ■ | ■ | ■ | | | | | | | |
| Fixed shoulder support / Vaste schoudersteun / Support oreillettes fixe / Nicht verstellbare Schulterstützen - 28 | | | | | | | | | | | | | ■ | ■ | ■ | ■ | ■ | ■ | ■ |

ACCESSORIES



| | Fuzion | | | | | LAGUNA | | | | | | | ECHO | | | | | | |
|--|--------|---|---|---|---|---------|---------|------|------|--------|-----------|-------------|---------|---------|------|------|--------|-----------|-------------|
| | Ino | | | | | CLASSIC | HARMONY | WOOD | COSY | FOREST | FOREST NS | HOSPITAL NS | CLASSIC | HARMONY | WOOD | COSY | FOREST | FOREST NS | HOSPITAL NS |
| Fixed serum holder with 2 hooks / Vaste serumhouder met 2 haken / Porte-sérum fixe avec 2 crochets / Fester Infusionshalter mit 2 Haken - 1 | ■ | ■ | ■ | ■ | ■ | | | | ■ | ■ | ■ | ■ | | | | ■ | ■ | ■ | ■ |
| Extendible serum holder with 4 hooks / Uitschuifbare serumhouder met 4 haken / Porte-sérum télescopique avec 4 crochets / Ausziehbarer Infusionshalter mit 4 Haken - 2 | ■ | ■ | ■ | ■ | ■ | | | | | | | | | | | | | | |
| Synthetic dining tray / Eettafel kunststof / Tablette repas en matière synthétique / Serviertablett aus Kunststoff - 3 | | | ■ | ■ | ■ | | | ■ | ■ | ■ | ■ | ■ | | | ■ | ■ | ■ | ■ | ■ |
| Crotch post on dining tray / Abduktieklos op eettafel / Selle d'abduction sur tablette de repas / Abduktionskeil am Serviertablett - 4 | | | ■ | ■ | ■ | | | ■ | ■ | ■ | ■ | ■ | | | ■ | ■ | ■ | ■ | ■ |
| Suspension dining tray / Opberging eettafel / Fixation porte-tablette de repas / Aufhängungsmöglichkeit für Serviertablett - 5 | | | ■ | ■ | ■ | | | ■ | ■ | ■ | ■ | ■ | | | ■ | ■ | ■ | ■ | ■ |
| Coffee table / Koffietafel / Plateau pour le café / Kaffeetisch - 6 | ■ | ■ | ■ | ■ | ■ | | | | | | | | | | | | | | |
| Narrowing cushion head support / Anatomische reductor hoofdsteen / Réducteur anatomique pour appui-tête / Anatomische Reduktor-Kopfstütze - 7 | ■ | ■ | ■ | ■ | ■ | | | | | | | | | | | | | | |
| Narrowing cushion legs / Anatomische reductor beensteen / Réducteur anatomique pour repose-jambes / Anatomische Reduktor-Kopfstütze - 8 | ■ | ■ | ■ | ■ | ■ | | | | | | | | | | | | | | |
| Narrowing cushion torso / Anatomische reductor romp / Réducteur anatomique pour corps / Anatomische Reduktor-Korpus - 9 | ■ | ■ | ■ | ■ | ■ | ■ | ■ | ■ | ■ | ■ | ■ | ■ | ■ | ■ | ■ | ■ | ■ | ■ | ■ |
| Urine bag holder / Urinezakhouder / Porte-sac à urine / Urinbeutelhalter - 10 | | | | ■ | ■ | | | | | ■ | ■ | ■ | | | | | ■ | ■ | ■ |
| Multifunctional (urine) bag holder / Multifunctionele (urine)zakhouder / Porte-sac (à urine) multifunction / Multifunktionaler (Urin-)Beutelhalter - 11 | ■ | ■ | ■ | ■ | ■ | | | | | | | | | | | | | | |
| Oxygen bottle holder / Zuurstoffleshouder / Porte-bouteille d'oxygène / Sauerstoffflaschenhalterung - 12 | ■ | ■ | ■ | ■ | ■ | ■ | ■ | ■ | ■ | ■ | ■ | ■ | | | | | | | |
| Removable head cushion / Los nekkussen / Repose-nuque amovible / Loses Nackenkissen - 13 | ■ | ■ | ■ | ■ | ■ | ■ | ■ | ■ | ■ | ■ | ■ | ■ | ■ | ■ | ■ | ■ | ■ | ■ | ■ |
| Separate fixation belt / Losse fixatieriem / Ceinture de fixation séparée / Loses Fixierband - 14 | ■ | ■ | ■ | ■ | ■ | ■ | ■ | ■ | ■ | ■ | ■ | ■ | ■ | ■ | ■ | ■ | ■ | ■ | ■ |
| Elevating orthopedic leg rest / Verstelbare orthopedische beensteen / Repose-jambes articulé / Orthopädischen Beinstütze - 15 | ■ | ■ | ■ | ■ | ■ | | | | | | | | | | | | | | |
| Removable and rechargeable battery / Extra batterij / Batterie supplémentaire / Zusätzliche Batterie - 16 | ■ | ■ | ■ | ■ | ■ | | | | | | | | | | | | | | |
| Multi directional anatomically shaped armrest / Multidirectionele anatomisch gevormde armluning / Accoudoir multidirectionnel de forme anatomique / Anatomisch geformte, multidirectionale Armlehne - 17 | | | | | ■ | | | | | | | | | | | | | | |
| Footrest fixed / Voetenbank vast / Repose-pieds fixe / Fußbank fix - 18 | | | | | | ■ | ■ | ■ | ■ | ■ | ■ | ■ | ■ | ■ | ■ | ■ | ■ | ■ | ■ |
| Footrest adjustable / Voetenbank verstelbaar / Repose-pieds réglable / Fußbank Verstellbar - 19 | | | | | | ■ | ■ | ■ | ■ | ■ | ■ | ■ | ■ | ■ | ■ | ■ | ■ | ■ | ■ |

STANDARD MODEL

| | VENTO | BREZZA | ZETA | NOVA |
|---|-------|--------|------|------|
| Integrated manual head adjustment / Geïntegreerde manuele hoofdstelling / Réglage manuel de la tête intégré / Integrierte manuell schwenkbare Kopfstütze - 1 | ■ | | ■ | ■ |
| Seating Heights / Zithoogte / Hauteur d'assise / Sitzhöhe small - medium - large - 2 | ■ | | ■ | ■ |
| Solid beech legs / Poten Massief beuken / Pieds Hêtre massif / Beine in massiver Buche - 3 | | ■ | | |
| Legs in stainless steel / Poten in RVS / Pieds en acier inoxydable / Beine in Edelstahl - 4 | ■ | | | |
| Black metal crossed foot / Zwarte metalen kruisvoet / Pieds croisé en métal noir / Schwarzer Metallkreuzfuß - 5 | | | ■ | ■ |
| Built-in manual control integrated into the right side panel / Ingebouwde handbediening in rechter zijpand verwerkt / Commande manuelle intégrée dans le panneau latéral droit / Eingebaute Handbedienung im rechten Seitenteil - 6 | ■ | | ■ | ■ |
| Non-integrated electric manual control / Losse elektrische handbediening / Commande manuelle électrique non intégrée / Separate elektrische Handbedienung - 7 | | ■ | | |



VENTO



BREZZA

OPTIONS



| | VENTO | BREZZA | ZETA | NOVA |
|---|-------|--------|------|------|
| Wheels Ø75 mm, 2 with brake / Wielen Ø75 mm, 2 met rem / Roulettes Ø75 mm, dont 2 avec frein / Doppellaufröle Ø75 mm: 2 mit Feststeller - 1 | ■ | | | |
| Trolley / Trolley / Chariot / Unterwagen - 2 | | ■ | | |
| Legs in synthetic material (black) / Poten in kunststof (zwart) / Pieds en matière synthétique (noir) / Beine in Kunststoff (schwarz) - 3 | | ■ | | |
| Stainless steel footplate / RVS schotelvoet / Piede disque en acier inoxydable / Edelstahl-Tellerfuß - 4 | | | ■ | ■ |
| Battery / Batterij / Batterie / Batterie - 5 | ■ | ■ | ■ | ■ |
| Non-integrated manual electric control / Losse elektrische handbediening / Commande manuelle électrique non intégrée / Separate elektrische Handbedienung - 6 | ■ | | | |
| Stand-up assistance / sta-op-functie / aide automatique à la mise en position debout / Aufstehfunktion (EL2) - 7 | | | ■ | ■ |
| With electric head adjustment / Met elektrische hoofdstelling / Avec réglage électrique de la tête / Mit elektrischer Kopfverstellung (EL2) - 8 | | | ■ | ■ |



ZETA



NOVA

ACCESSORIES

| | VENTO | BREZZA | ZETA | NOVA |
|---|-------|--------|------|------|
| Removable headcushion / Los nekkussen / Repose-tête amovible / Abnehmbares Nackenkissen - 1 | | ■ | | |

Interested?

Let's talk. Call us for more information.

Belgium +32(0)51 489 258
Netherlands +31(0)344 619 844
France +33(0)320 545 019
Germany +49(0)525 898 090 0
Switzerland +41 (0)21 697 05 05



'Moments Furniture' designs, manufactures and markets healthcare furniture and interiors since 1935. Innovation, quality and craftsmanship are central to our unique overall concept.

Special thanks to:
Muze'um L, Roeselare (B) • AZ Monica, Deurne (B) • AZ Maria Middelaers, Gent (B)
ZNA – Middelheim, Antwerpen (B) • WZC Avondrust, Varsenare (B) • Dominique Belpaire



moments furniture

Deefakkerstraat 2
8770 Ingelmunster
Belgium
T. +32(0)51 489 258

W2 moments

Edisonstraat 25
4004 JL Tiel
Netherlands
T. +31(0)344 619 844

moments furniture

130, Boulevard de la Liberté
59000 Lille
France
T. +33(0)320 545 019

FMB Care

Am Schlinge 8
33154 Salzkotten
Germany
T. +49(0)525 898 090 0

moments furniture

Chemin du croset 9
1024 Ecublens
Switzerland
T. +41 (0)21 697 05 05

[momentsfurniture.com](https://www.momentsfurniture.com)

